



Aircraft Manufacturing & Design LLC  
Heart of Georgia Regional Airport  
441 Airport Road, Eastman Georgia 31023 USA  
[www.newplane.com](http://www.newplane.com)  
TEL: (478) 374-2-SKY FAX:(478) 374-2793

## NOTIFICATION

**Release Date:**

Wednesday, January 07, 2009

**Effective Date:**

Wednesday, January 07, 2009

**Subject/Purpose:**

Securing control surfaces when aircraft is parked

**Limitations:**

None

**Affected Models:**

All AMD models

**Serial numbers:**

All

**Notification Number:**

Wednesday, January 07, 2009

**Does this Notice supersede another document?**

No

## Discussion:

An AMD customer has reported considerable aileron damage to his Zodiac after not having tightly secured his control surfaces when the aircraft was tied down outdoors (parked). High winds, causing abrupt and extreme aileron deflections, did considerable damage to the ailerons. (See customer anecdote below)

## Corrective Action:

Inspect your control system, specifically the ailerons. Also see AMD Safety Alert of October 29, 2008. Only proceed with operation of the aircraft when control systems show no excessive wear, tear or damage. Caution: Some damage can be missed if inspections are cursory; careful inspections are the best way to insure the aircraft is airworthy.

- a) If there is any deformation at the ailerons, please contact AMD immediately. Do not fly the aircraft until a certified mechanic has fixed the problem and has signed off the aircraft in the airframe log book.
- b) Installation of supplementary aileron gussets as per page 3 of this NOTIFICATION is recommended for aircraft kept outside. Part numbers 65-W-2-5 and 65-W-2-6.
- c) Controls can be secured and/or locked by attaching the seatbelts tightly around the control stick and/or by using control stops similar to those shown on photos below (see page 4). When high winds are expected, rudder pedals should also be secured/locked. Controls should always be secured/locked when the aircraft is parked outdoors.
- d) Remember to remove all control stops before flying (add this step to your pre-flight walk-around checklist).

## Reminder

AMD reminds the Owner/Operator of any AMD aircraft that compliance with all Safety Directives, Aircraft Operating Instructions, Maintenance Manuals as well as the reporting of any and all Safety of Flight or Service Difficulties by the Owner/Operator is *mandatory* for the operation of an SLSA aircraft.

### ***Aircraft owner anecdote:***

*"The aileron damage [see photos below] occurred while the plane was tied down on the ramp. Winds were 30MPH gusting to 50MPH straight against the tail. I had the seat belt around the control stick with another strap wrapped one time around the stick in the opposite direction connected to each rudder pedal. All was secure when I left the plane but the seat belt appeared to slip some in the adjustment as well as the rudder and pedals ended up at full deflection over the duration of the wind."*



## SUPPLEMENTARY AILERON GUSSETS

Aircraft are designed to meet moving air masses head-on. When tied-down outside rather than inside a hangar, an aircraft can be subjected to strong winds from any direction. Zenair has received reports of small unseemly kinks in the aileron skin near the inboard hinge area, presumably caused while the aircraft was parked outside without a control lock in place; installation of this gusset is recommended to reduce the risk of potential damage to the area. These gussets are recommended for the Zodiac CH601XL and are included standard on the Zodiac CH650. See the drawing below for details.

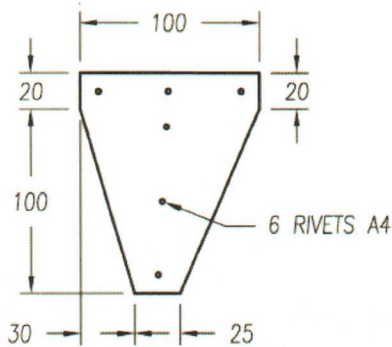

**65-W-2-5** **AILERON RIB #2 GUSSET**  
 t=.025" 6061-T6 (2 REQ'D)

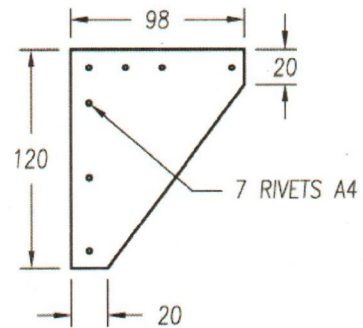

**65-W-2-6** **AILERON RIB #1 GUSSET**  
 t=.025" 6061-T6 (2 REQ'D)

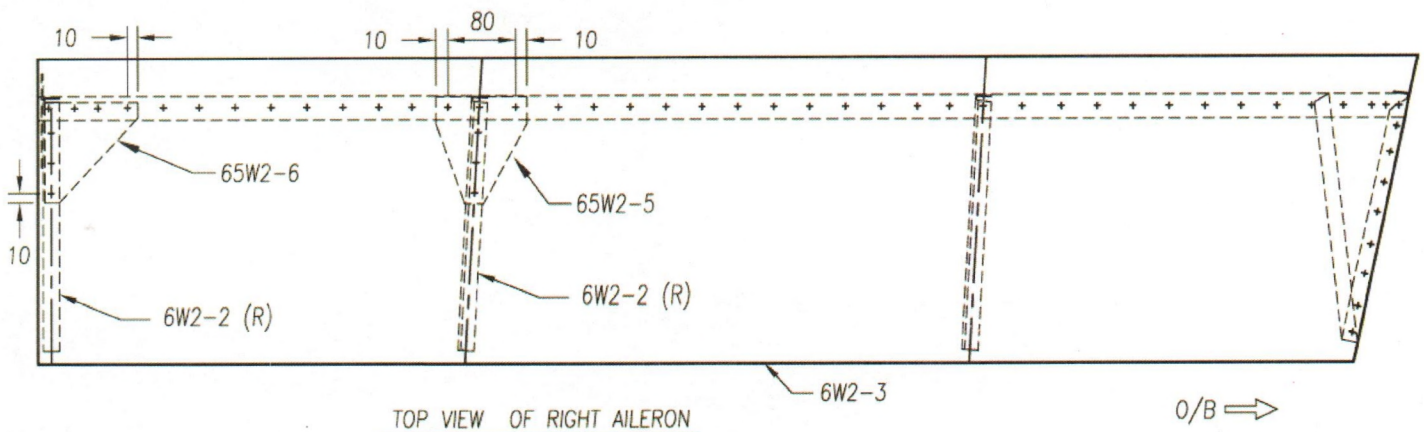



Control locks are highly recommended to prevent damage while the aircraft is on the ground. Below are a couple pictures of simple control locks that can easily be made at home from a couple tennis balls or plywood and some bungee cord.



Above: Aileron control lock made from two tennis balls and a bungee cord.



Above: Elevator control lock made from two pieces of plywood and a bungee cord.



Photos supplied by customer who confirmed that damage was due to high winds when aircraft was tied-down outside without controls adequately locked.

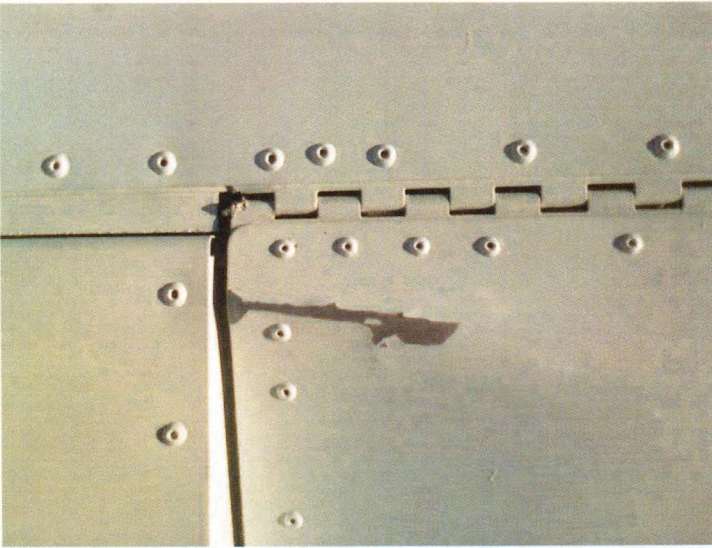

Above – Top of aileron damage

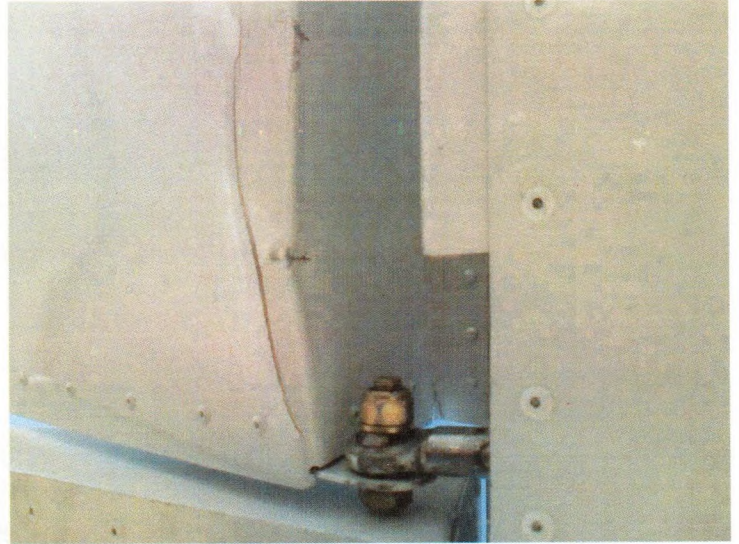

Above – Bottom of aileron damage

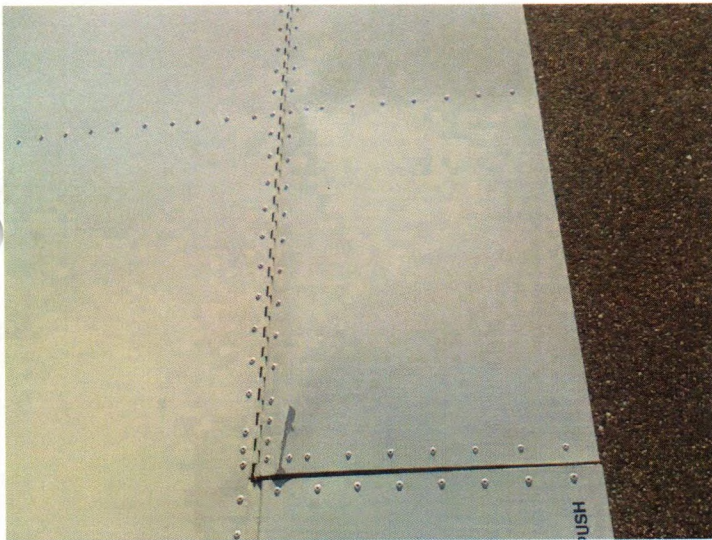

Above – Top of aileron damage

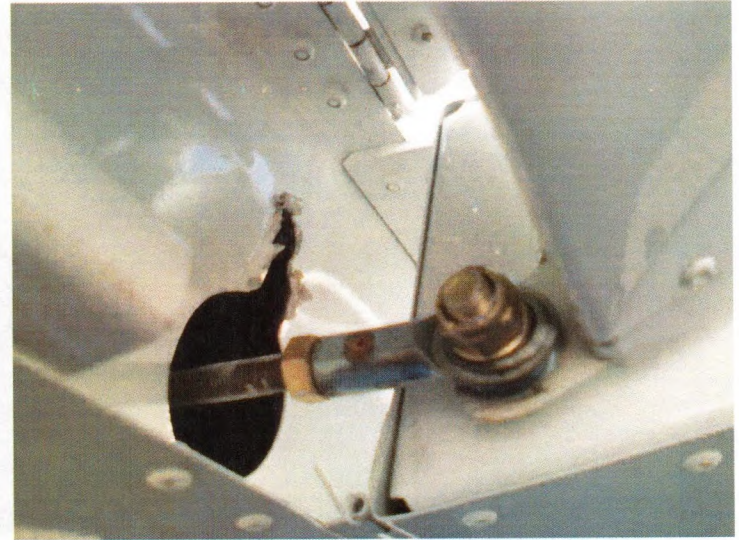

Above – Rear spar damage